

User Manual

KSTAR

**1-3KVA
HYBRID INVERTER**

Table Of Contents

ABOUT THIS MANUAL.....	1
Purpose	1
Scope	1
SAFETY INSTRUCTIONS	1
INTRODUCTION.....	2
Features.....	2
Basic System Architecture.....	2
Product Overview.....	3
INSTALLATION.....	4
Unpacking and Inspection.....	4
Preparation	4
Mounting the Unit.....	4
Battery Connection	6
AC input/output Connection.....	7
PV Connection.....	8
Final Assembly.....	10
OPERATION	11
Power ON/OFF	11
Operation and Display Panel.....	11
LCD Display Icons	12
LCD Setting	14
Display Setting.....	17
Operating Mode Description	18
Alarm Behavior Table.....	20
SPECIFICATIONS	21
Table 1 Line Mode Specifications.....	21
Table 2 Inverter Mode Specifications	22
Table 3 Charge Mode Specifications.....	23
Table 4 General Specifications	24
Troubleshooting.....	24
Appendix: Approximate Back-up Time Table	26

ABOUT THIS MANUAL

Purpose

This manual describes the assembly, installation, operation and troubleshooting of this unit. Please read this manual carefully before installations and operations. Keep this manual for future reference.

Scope

This manual provides safety and installation guidelines as well as information on tools and wiring.

SAFETY INSTRUCTIONS



WARNING: This chapter contains important safety and operating instructions. Read and keep this manual for future reference.

1. Before using the unit, read all instructions and cautionary markings on the unit, the batteries and all appropriate sections of this manual.
2. **CAUTION**—To reduce risk of injury, charge only deep-cycle lead acid type rechargeable batteries.
3. Do not try to repair or open the unit. Take it to a qualified service center when needed. Incorrect installation may result in a risk of electric shock or fire.
4. Disconnect all wirings before attempting any maintenance or cleaning.
5. **CAUTION** - Only qualified personnel can install and troubleshoot this inverter.
6. **NEVER** charge a frozen battery.
7. For optimum operation of this hybrid inverter, please follow required spec to select appropriate cable size. It's very important to correctly operate this hybrid inverter.
8. Be very cautious when working with metal wrist watch and tools on or around batteries. A potential risk exists for short circuit batteries terminals with explosion.
9. Please strictly follow installation procedure when you want to disconnect AC or DC connectors.
10. This hybrid inverter should be connected to a permanent grounded wiring system.

INTRODUCTION

This is a pure sine wave stand-alone hybrid inverter system combining the function of inverter, AC charger and optional solar charger, and provides a long run-time uninterruptible power supply. Its comprehensive LCD display provides system status, and user-friendly panel eases parameters settings.

Features

- High-frequency switching technology, compact size and light weight
- Pure sine wave output for wide range of applications
- Build-in solar charger controller with PWM OR MPPT technology to optimize the power utilization(some models don't have this option)
- Efficient DC-to-AC conversion minimizing energy loss
- Standby Charging Mode enables battery charging even when the unit is switched off
- Intelligent cooling fan control
- Input/output isolated design for the maximum operation safety
- LCD displays for detailed status
- Configurable AC input voltage range and priority for AC or PV input
- Supports Home Appliances / Office Equipment/ Lighting Equipment/ Motor-based Equipment (such as Fan, Air-Conditioner, Washing Machines etc)
- Input low voltage / Overload / Short circuit / Low battery alarm / Input over voltage / Over temperature protections.
- Supports both rack and wall-mount installation

Basic System Architecture

The following illustration shows basic application for this hybrid inverter. It also includes following devices to have a complete running system:

- Generator or Utility.
- PV modules

Consult with your system integrator for other possible system architectures depending on your requirements.

This inverter can power all kinds of appliances in home or office environment, including motor-type appliances such as tube light, fan, refrigerator and air conditioner.

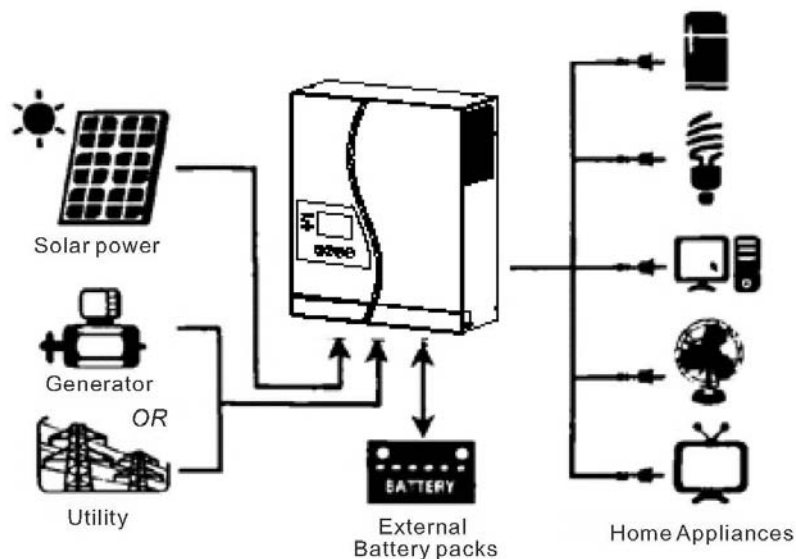
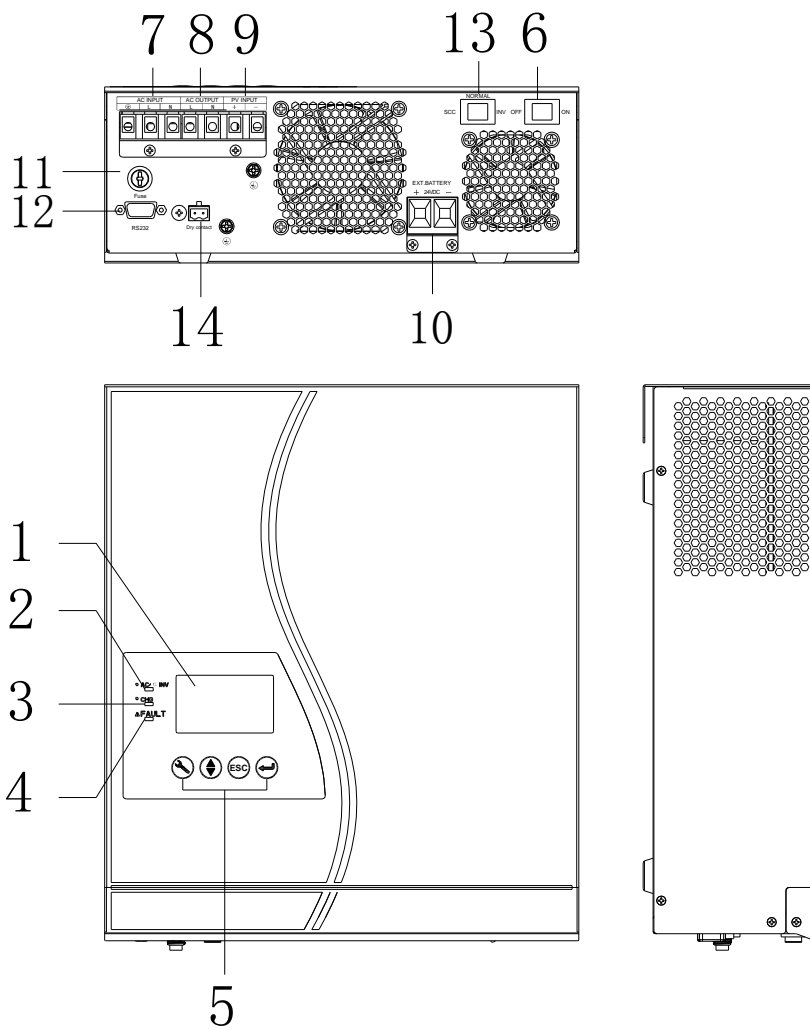

Figure 1 Hybrid Power System

Product Overview



1. LCD display
2. Status indicator
3. Charging indicator
4. Fault indicator
5. Function buttons
6. Power on/off switch
7. AC input
8. AC output
9. PV input
10. Battery input
11. AC Fuse
12. RS232 communication port
13. Maintenance switch
14. Dry contact

INSTALLATION

Unpacking and Inspection

Before installation, please inspect the unit. Be sure that nothing inside the package is damaged. You should have received the following items inside the box:

- The unit x 1
- User manual x 1
- DC Fuse x 1
- AC Fuse x 1
- Ring terminal x 1
- Strain relief plate x 2
- Screws x 4

Preparation

Before connecting all wirings, please take off bottom cover by removing two screws as shown below.

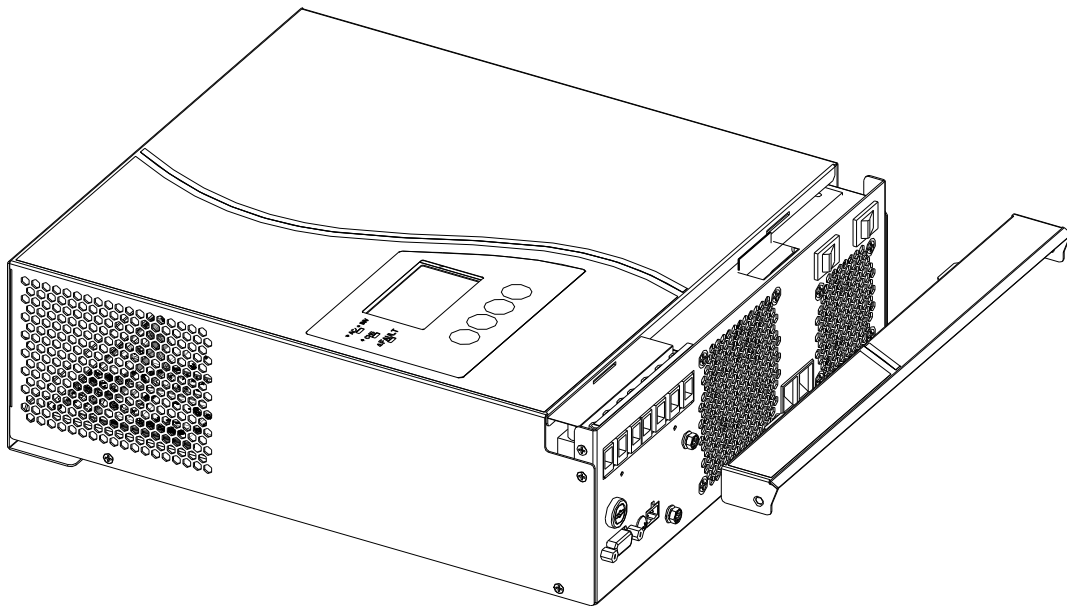

Mounting the Unit

Consider the following points before selecting where to install:

- Do not mount the inverter on flammable construction materials.
- Mount on a solid surface
- Install this inverter at eye level in order to allow the LCD display to be read at all times.
- For proper air circulation to dissipate heat, allow a clearance of approx. 20 cm to the side and approx. 50 cm above and below the unit.
- The ambient temperature should be between 0°C and 45°C to ensure optimal operation,
- The recommended installation position is to be adhered to the wall vertically.
- Be sure to keep other objects and surfaces as shown in the diagram to guarantee sufficient heat dissipation and to have enough space for removing wires.

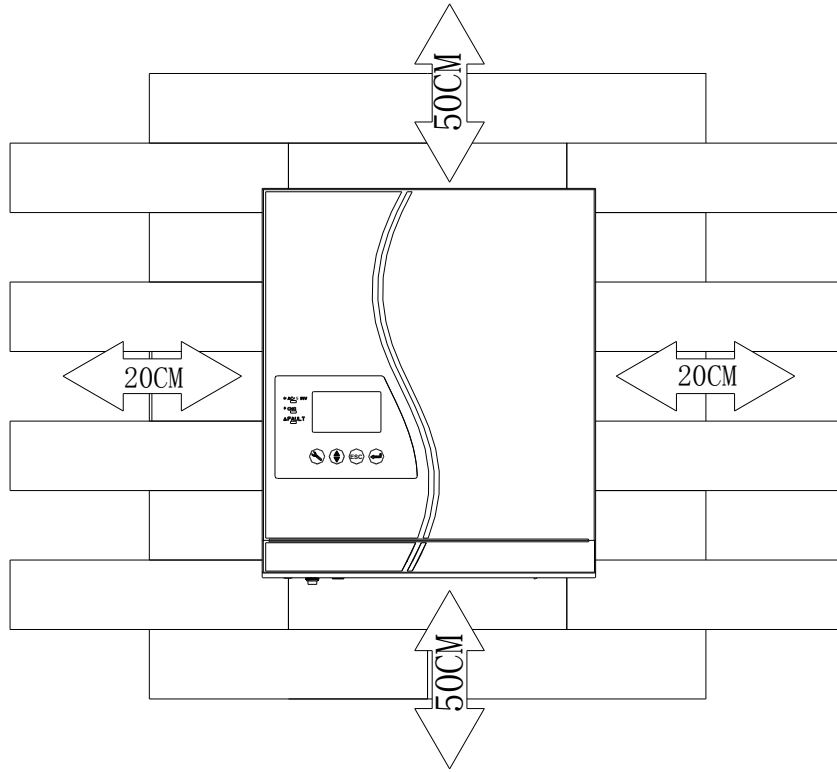

⚠ SUITABLE FOR MOUNTING ON CONCRETE OR OTHER NON-COMBUSTIBLE SURFACE ONLY.

Install the unit by screwing two screws. It's recommended to use M4 or M5 screws.

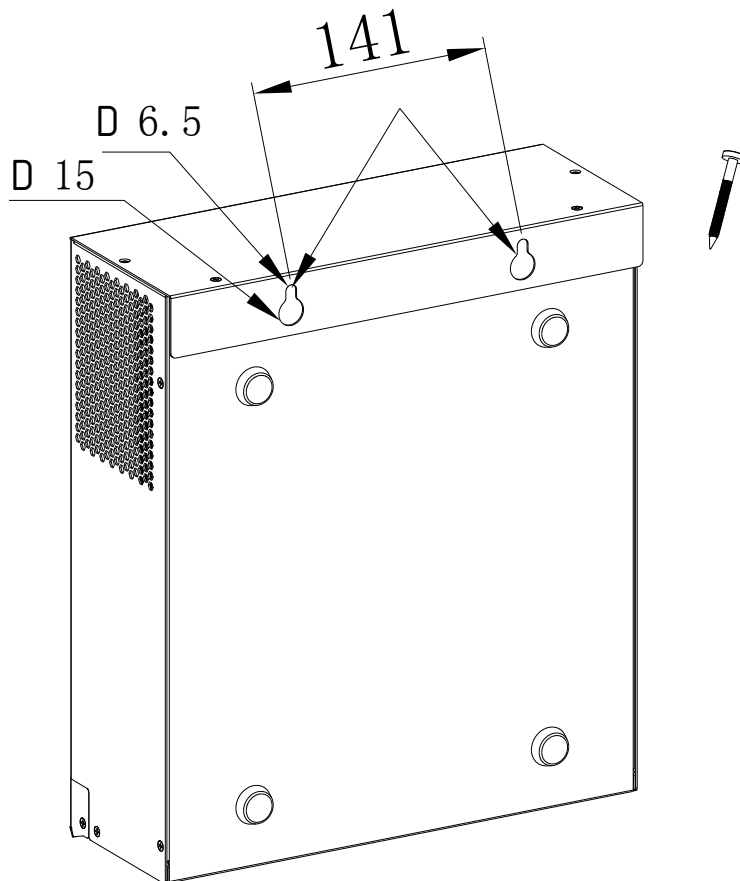

Battery Connection

CAUTION: For safety operation and regulation compliance; it's requested to install a separate DC over-current protector or disconnect device between battery and inverter. It may not be requested to have a disconnect device in some applications, however, it's still requested to have over-current protection installed. Please refer to typical amperage in below table as required fuse or breaker size.

WARNING! All wiring must be performed by a qualified personnel.

WARNING! It's very important for system safety and efficient operation to use appropriate cable for battery connection. To reduce risk of injury, please use recommended cable as below.

Recommended battery cable size:

Model	Wire Size	DC Cable (mm ²)	Torque value (max)
1KVA-12V/3KVA-24V	1 x 4AWG	25	2 Nm

Please follow below steps to implement battery connection:

1. Remove insulation sleeve 18 mm for positive and negative conductors.
2. Suggest to put bootlace ferrules on the end of positive and negative wires with a proper crimping tool.
3. Fix strain relief plate to the inverter by supplied screws as shown in below chart.

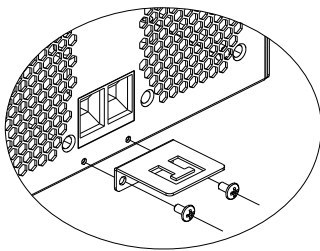
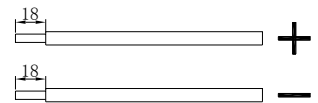

4. Connect all battery packs as below chart.

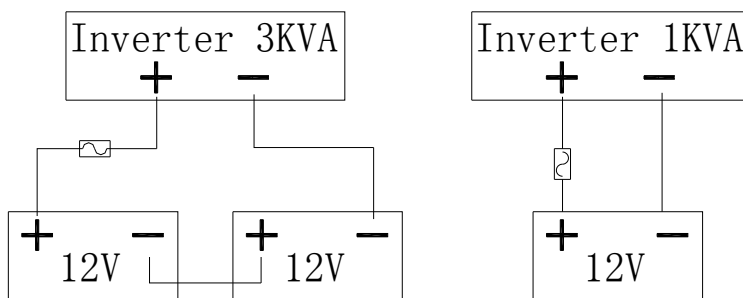

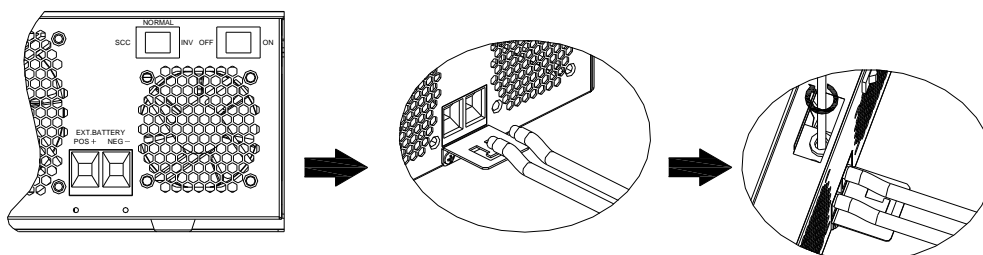

5. Insert the battery wires flatly into battery connectors of inverter and make sure the bolts are tightened with torque of 2 Nm in clockwise direction. Make sure polarity at both the battery and the inverter/charge is correctly connected and conductors are tightly screwed into the battery terminals.

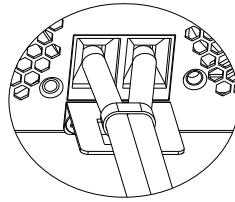

6. To firmly secure wire connection, you may fix the wires to strain relief with cable tie.



 **WARNING: Shock Hazard**
Installation must be performed with care due to high battery voltage in series.

 **CAUTION!!** Before making the final DC connection or closing DC breaker/disconnector, be sure positive (+) must be connected to positive (+) and negative (-) must be connected to negative (-) terminal.

AC input/output Connection

CAUTION!! Before connecting to AC input power source, please install a separate AC breaker between inverter and AC input power source. This will ensure the inverter can be securely disconnected during maintenance and fully protected from over current of AC input. The recommended spec of AC breaker is 10A for 1kVA ,32A for 3KVA.

CAUTION!! Terminal blocks are with “AC INPUT” and "AC OUTPUT” marking always check labels to avoid wrong connection.

WARNING! All wiring must be performed by a qualified personnel.

WARNING! It's very important for system safety and efficient operation to use appropriate cable for AC input connection. Always use recommended AC cable size as below.

Suggested cable requirement for AC wires

Model	Wire Size	Cable (mm2)	Torque value
1KVA	16AWG	2	0.6 Nm
3KVA	12AWG	4	1.2 Nm

Please follow below steps to implement AC input/output connection:

1. Before making AC input/output connection, be sure to open DC protector or disconnector first.
2. Remove insulation sleeve 10mm for six conductors. And shorten phase L and neutral conductor N 3 mm.
3. Insert AC input wires according to polarities indicated on terminal block and tighten the terminal screws. Be sure to connect PE protective conductor (⊕) first.

⊕ → **Ground (yellow-green)**

L → **LINE (brown or black)**

N → **Neutral (blue)**

 **WARNING:**
Be sure that AC power source is disconnected before attempting to hardwire it to the unit

4. Then, insert AC output wires according to polarities indicated on terminal block and tighten terminal screws. Be sure to connect PE protective conductor (⊕) first.

⊕ → Ground (yellow-green)

L → LINE (brown or black)

N → Neutral (blue)

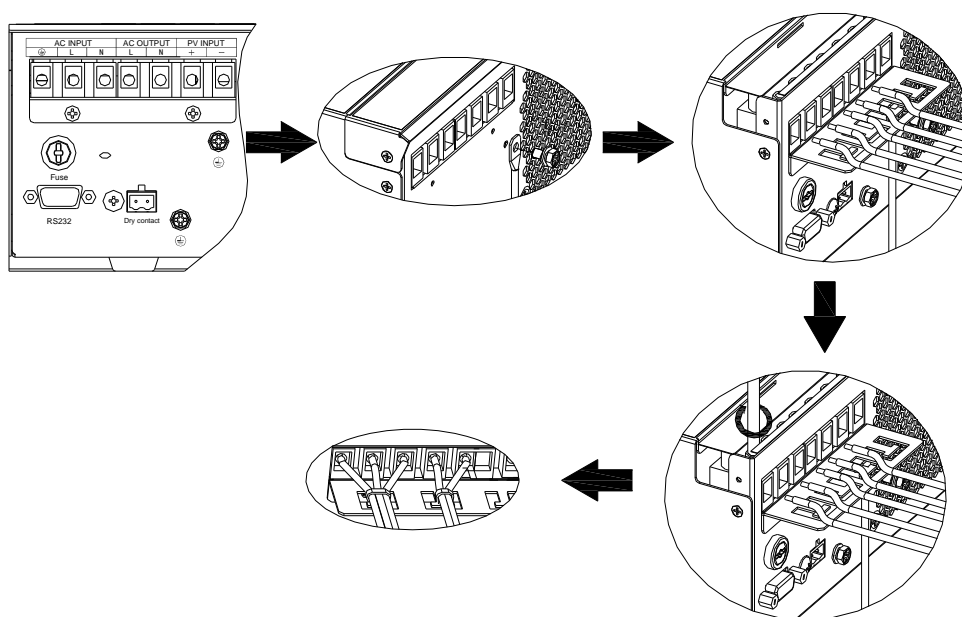

5. Make sure the wires are securely connected.

PV Connection

CAUTION: Before connecting to PV modules, please install separately a DC circuit breaker between inverter and PV modules.

WARNING! It's very important for system safety and efficient operation to use appropriate cable for PV module connection. To reduce risk of injury, please use the proper recommended cable size as below.

Model	Wire Size	Cable (mm ²)	Torque value (max)
1KVA-12V	1X10AWG	6	1.6 Nm
3KVA-24V	1X12AWG	4	1.6 Nm

PV Module Selection: (Only for the model with PWM solar charger)

When selecting proper PV modules, please be sure to consider below requirements first:

1. Open circuit Voltage (Voc) of PV modules not exceeds max. PV array open circuit voltage of inverter

Charging Current (PWM)	50Amp
System DC Voltage	24Vdc
Operating Voltage Range	30~32Vdc
Max. PV Array Open Circuit Voltage	60Vdc

2. Max. Power Voltage (Vmp) of PV modules should be close to best Vmp of inverter or within Vmp range to get best performance. If one PV module cannot meet this requirement, it's necessary to have several PV modules in series connection.

Maximum PV module numbers in Series: $V_{mp} \text{ of PV module} \times X \text{ pcs} \approx \text{Best Vmp of Inverter or Vmp range}$

PV module numbers in Parallel: $\text{Max. charging current of inverter} / I_{mp}$

Total PV module numbers = maximum PV module numbers in series * PV module numbers in parallel

Take 3KVA model inverter as an example to select proper PV module. After considering Voc of PV module not exceed 60Vdc and max. Vmpp of PV module close to 30Vdc or within 30Vdc ~ 32Vdc, we can choose PV module with below specification.

Maximum Power (Pmax)	260W	Max. PV module numbers in series 1→30.9 x 1 ≈ 30 ~ 32
Max. Power Voltage Vmpp(V)	30.9V	
Max. Power Current Impp(A)	8.42A	PV module numbers in parallel 6→50 A/8.42 Total PV module numbers 1x6 = 6
Open circuit Voltage Voc(V)	37.7V	
Short Circuit Current Isc(A)	8.89A	

Maximum PV module numbers in Series: 1

PV module numbers in Parallel: 6

Total PV module numbers: 1x6 = 6

PV Module Selection: (Only for the model with MPPT solar charger)

When selecting proper PV modules, please be sure to consider below parameters:

1. Open circuit Voltage (Voc) of PV modules not exceeds max. PV array open circuit voltage of inverter.
2. Open circuit Voltage (Voc) of PV modules should be higher than min, battery voltage.

INVERTER MODEL	3KVA
Max. PV Array Open Circuit Voltage	75Vdc
PV Array MPPT Voltage Range	30~75Vdc

Take 250Wp PV module as an example. After considering above two parameters, the recommended module configurations for 3KVA are listed as below table.

Maximum Power (Pmax)	250W	3KVA; 2 pieces in serial and 2 sets in parallel.
Max. Power Voltage Vmpp(V)	30.1V	
Max. Power Current Impp(A)	8.3A	
Open Circuit Voltage Voc(V)	37.7V	
Short Circuit Current Isc(A)	8.4A	

PV Module Wire Connection

Please follow below steps to implement PV module connection:

1. Remove insulation sleeve 10 mm for positive and negative conductors.
2. Suggest to put bootlace ferrules on the end of positive and negative wires with a proper crimping tool.
3. Fix strain relief plate to the inverter with supplied screws as shown in below chart.

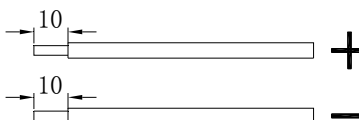
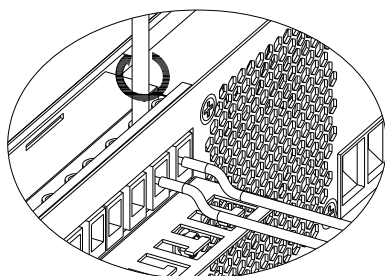

4. Check correct polarity of wire connection from PV modules and PV input connectors. Then, connect positive pole (+) of connection wire to positive pole (+) of PV input connector. Connect negative pole

(-) of connection wire to negative pole (-) of PV input connector. Screw two wires tightly in clockwise direction, Recommended tool: 4mm blade screwdriver

5. To ensure wires are securely connected, you fix wires to the strain relief with cable tie.

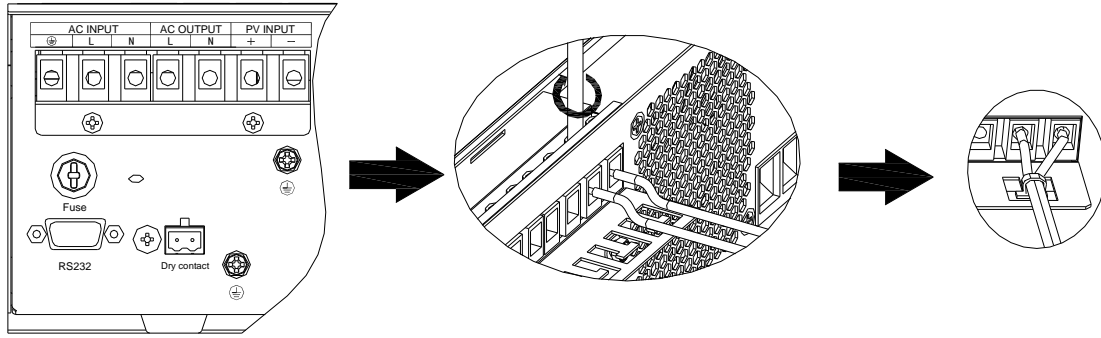

Final Assembly

After connecting all wirings, please put bottom cover back by screwing two screws as shown below.

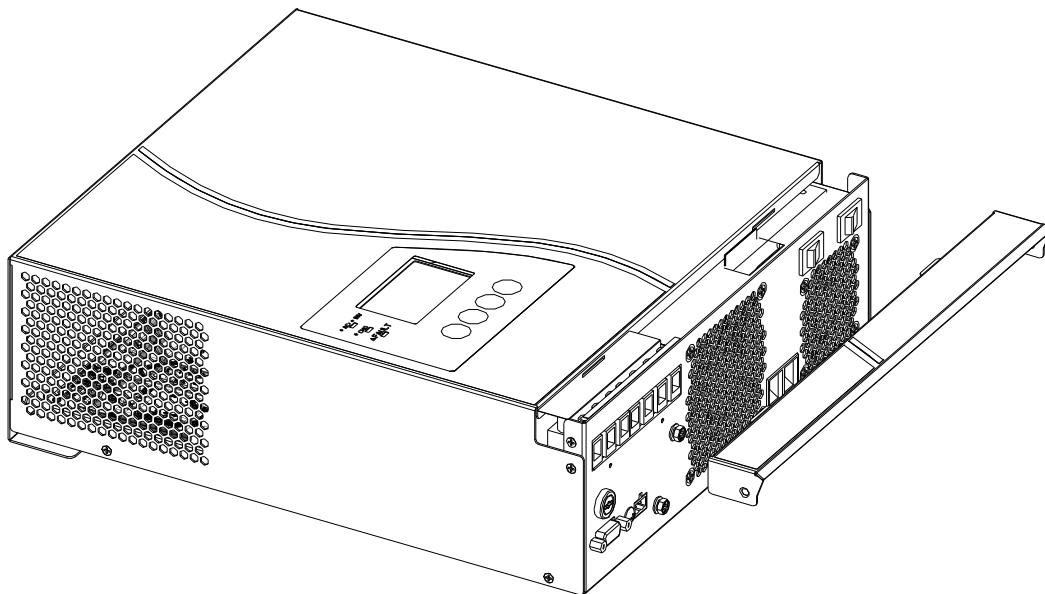

CAUTION: Before turning on the unit, please check the position of maintenance switch. Put the switch to “NORMAL” position if not. Other position of the switch like “INV” or “SCC” is used for only service purpose.

OPERATION

Power ON/OFF

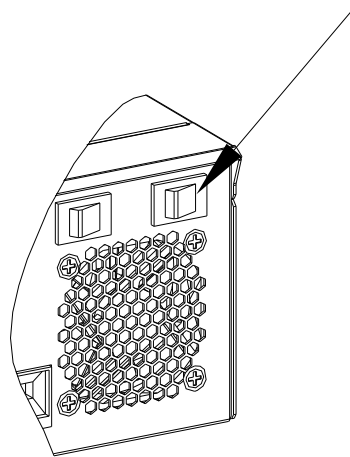

Once the unit has been properly installed and the batteries are connected well, simply press On/Off switch (located on the button of the case) to turn on the unit.

Operation and Display Panel



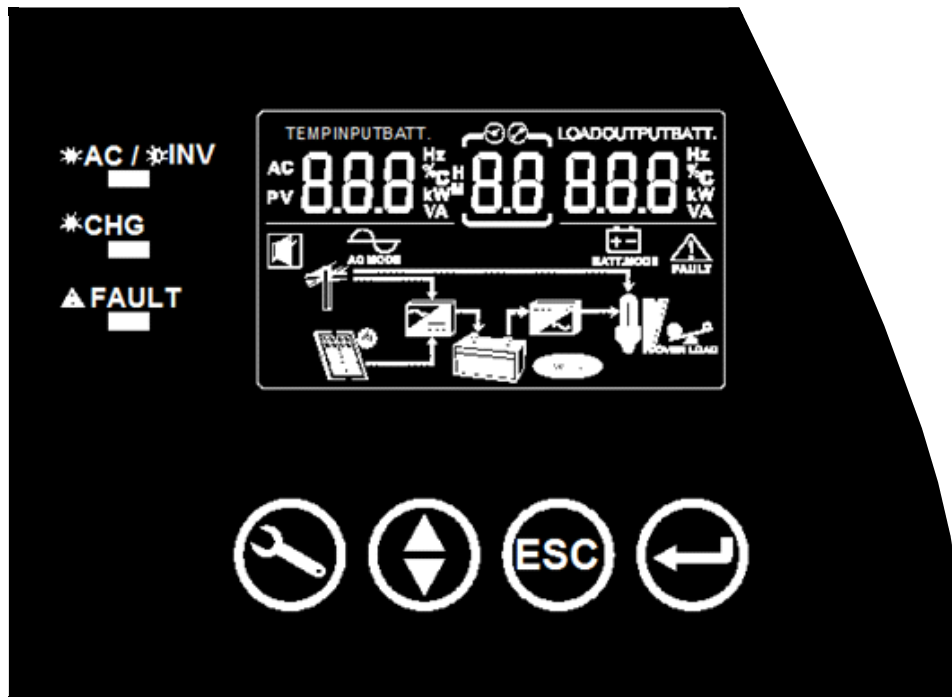

The operation and display panel, shown in below chart, is on the front panel of the inverter. It includes three indicators, four function keys and a LCD display, indicating the operating status and input/output power information.



LED Indicator





LED Indicator		Messages	
☀️ AC / ⚡️ INV	Green	Solid On	Output is powered by utility in line mode.
		Flashing	Output is powered by battery or PV in battery mode.
☀️ CHG	Green	Solid On	Battery is fully charged.
		Flashing	Battery is charging.
⚠️ FAULT	Red	Solid On	Fault occurs in the inverter.
		Flashing	Warning condition occurs in the inverter.

Button function

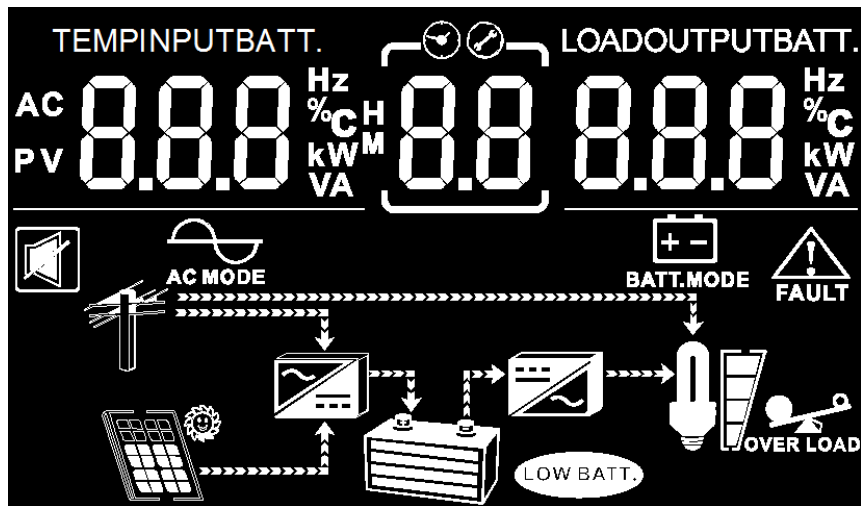
Button	Function	Description
	Configuration	Enter configuration mode, and switch between setting menus
	Up/down	Move to previous/next setting option
	ESC	Return to main menu
	Enter	Confirm setting

LCD Display Icons



Icon	Function description
Input Source Information	
AC	Indicates the AC input.
PV	Indicates the PV input
INPUTBATT. 	Indicate input voltage, input frequency, PV voltage, charger current (if PV in charging for 3K models), charger power (only for MPPT models), battery voltage.
Configuration Program and Fault Information	
	Indicates the setting programs.
	Indicates the warning and fault codes.
Output Information	
LOADOUTPUTBATT. 	Indicate output voltage, output frequency, load percent, load in VA, load in Watt and discharging current.
Battery Information	

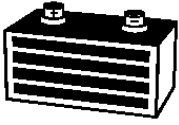





Indicates battery level by 0-24%, 25-49%, 50-74% and 75-100% in battery mode and charging status in line mode.

In AC mode, it will present battery charging status.

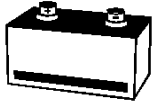
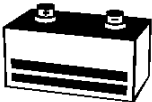
Status	Battery voltage	LCD Display
Constant Current mode / Constant Voltage mode	<2V/cell	4 Bars will flash in turns.
	2 ~ 2.083V/cell	Bottom bar will be on and the other three bars will flash in turns.
	2,083 ~ 2.167V/cell	Bottom two bars will be on and the other two bars will flash in turns.
	>2.167V/cell	Bottom three bars will be on and the top bar will flash.
Floating mode. Batteries are fully charged.		4 bars will be on.

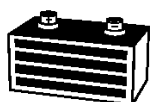
In battery mode, it will present battery capacity.

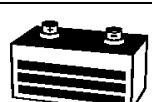
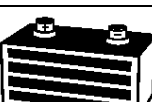
Load Percentage	Battery Voltage	LCD Display
Load >50%	< 1.65V/cell	
	1.85V/CCII ~ 1.933V/cell	
	1.933V/cell ~ 2.017V/cell	
	> 2.017V/cell	
Load < 50%	< 1.892V/cell	
	1.892V/cell ~ 1.975V/cell	
	1.975V/cell ~ 2.058V/cell	
	>2.058V/cell	

Load Information



Indicates overload.



Indicates the load level by 0-24%, 25-50%, 50-74% and 75-100%.

0%~25%

25%~50%

50%~75%

75%~100%











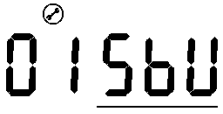
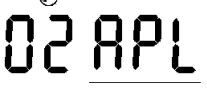

Mode Operation Information				
	Indicates unit connects to the mains.			
	Indicates unit connects to the PV panel.			
	Indicates load is supplied by utility power.			
	Indicates load is supplied by battery power or pv power.			
	Indicates the utility charger circuit is working.			
	Indicates the DC/AC inverter circuit is working.			
Mute Operation				
	Indicates unit alarm is disabled.			

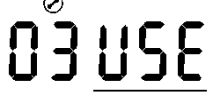
LCD Setting

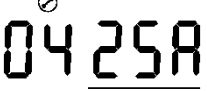
After pressing and holding “Configuration” button for 1 second, the unit will enter setting mode and switch between different setting items. Press “Up/down” button to switch between different setting parameters. And then, press “ENTER” button to confirm the selection or ESC button to exit.

Setting Programs:

Program	Description	Selectable option	
01	Output source priority: To configure load power source priority	Solar first ☉ 0150L	Solar energy provides power to the loads as first priority. If solar energy is not sufficient to power all connected loads, battery energy will supply power the loads at the same time. Utility provides power to the loads only when any one condition happens: -Solar energy is not available -Battery voltage drops to low-level warning voltage or the setting point in program 05.
		Utility first (default)	Utility will provide power to the loads as first priority. Solar and battery energy will provide

			power to the loads only when utility power is not available.
		SBU priority 	Solar energy provides power to the loads as first priority. If solar energy is not sufficient to power all connected loads, battery energy will supply power to the loads at the same time. Utility provides power to the loads only when battery voltage drops to either low-level warning voltage or the setting point In program 05.
02	AC input voltage range	Appliances (default) 	If selected, acceptable AC input voltage range will be within 90-280VAC
		UPS 	If selected, acceptable AC input voltage range will be within 170-280VAC
03	Battery type	AGM (default) 	Flooded 
		User-Defined 	If "User-Defined" is selected, battery charge voltage and low DC cut-off voltage can be set up in program 9,10 and 11.
04	Maximum utility charging current	Available options in 3KVA model:	
		10A 	25A(default) 
05	Setting voltage point back to utility source when selecting "SBU priority" or "Solar first" in program 01.	Available options in 3KVA model:	
		22.1V 	22.5V 
		23.0V 	23.4V 
		23.8V 	24.3V 
		24.7V	25.1V

		⊗ 05 24.7 _v BATT.	⊗ 05 25.1 _v BATT.
06	Setting voltage point back to battery mode when selecting "SBU priority" or "Solar first" in program 01.	Available options In 3KVA model:	
		Battery fully charged ⊗ 06 FUL BATT.	24.6V ⊗ 06 24.6 _v BATT.
		25.0V ⊗ 06 25.0 _v BATT.	25.4V ⊗ 06 25.4 _v BATT.
		25.8V ⊗ 06 25.8 _v BATT.	26.3V ⊗ 06 26.3 _v BATT.
		26.7V ⊗ 06 26.7 _v BATT.	27.2V ⊗ 06 27.2 _v BATT.
		27.6V ⊗ 06 27.6 _v BATT.	28.0V ⊗ 06 28.0 _v BATT.
		28.5V ⊗ 06 28.5 _v BATT.	28.9V ⊗ 06 28.9 _v BATT.
		07	Charger source priority: To configure charger source priority
Solar first ⊗ 07 C50	Solar energy will charge battery as first priority. Utility will charge battery only when solar energy is not available.		
Utility first ⊗ 07 CUE	Utility will charge battery as first priority. Solar energy will charge battery only when utility power is not available.		
Solar and Utility (default) ⊗ 07 SNU	Solar energy and utility will charge battery at the same time.		
Only Solar ⊗ 07 O50	Solar energy will be the only charger source no matter utility is available or not.		
If this hybrid inverter is working in Battery mode only solar energy can charge battery. Solar energy will charge battery if it's available and sufficient.			

08	Alarm control	Alarm on (default) 08 60N	Alarm off 08 60F
09	Bulk charging voltage (C.V voltage)	3KVA setting: 28.2V CU 09 28.2 _v ^{BATT.}	If self-defined is selected in program 3, this program can be set up. Setting range is from 25.0V to 32.0V for 3KVA model. Increment of each dick is about 0.1V.
10	Floating charging voltage	3KVA setting: 27.0V FLU 10 27.0 _v ^{BATT.}	If self-defined is selected in program 3, this program can be set up. Setting range is from 25.0V to 32.0V for 3KVA. Increment of each dick is about 0.1V.
11	Low DC cut-off voltage	3KVA default setting: 20.0V COU 11 20.0 _v ^{BATT.}	If self-defined is selected in program 3, this program can be set up. Setting range is from 20.0V to 24.0V for 3KVA model. Increment of each dick is about 0.1V. Low DC cut-off voltage will be fixed to setting value no matter what percentage of load is connected.

Display Setting

The LCD display information will be switched in turns by pressing “Up/down” key. The selectable numerical information is as: input voltage, input frequency, PV voltage, PV charging power, battery voltage, output voltage, output frequency, load in Watt, load in VA, rated Watt, rated VA, main CPU Version and second CPU Version.

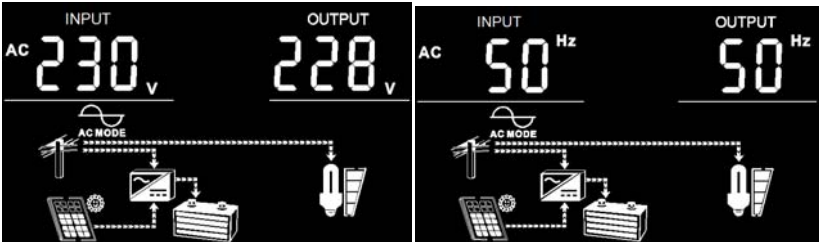
LCD Display	Remark
Note: The LCD display information will be switched in turns by pressing “UP” or “DOWN” button. The default page is ①, the display will show default page after pressing “ESC” button.	
	①. AC input voltage / frequency & AC output voltage /frequency

		②. Battery voltage & AC output voltage / frequency
		③. Battery voltage & Load VA /WATT
		④. PV voltage / PV charge current & AC output voltage / frequency
		⑤. Rating power KVA / KW & Firmware version U1/U2

Operating Mode Description

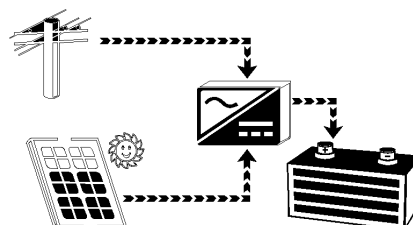
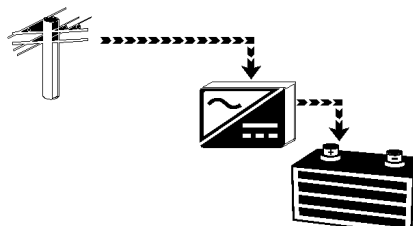
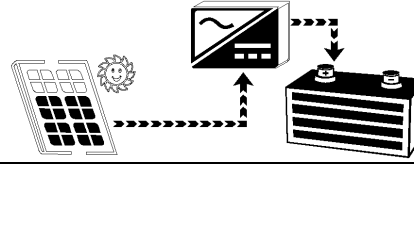
Operation mode	Description	LCD display
<p>Standby mode</p> <p>Note:</p> <p>*Standby mode: The Inverter is not turned on yet but at this time, the inverter can charge battery without AC output</p>	<p>No output is supplied by the unit but it still can charge batteries.</p>	<p>Charging by utility and PV energy.</p>  <p>Charging by utility.</p>  <p>Charging by PV energy.</p> 

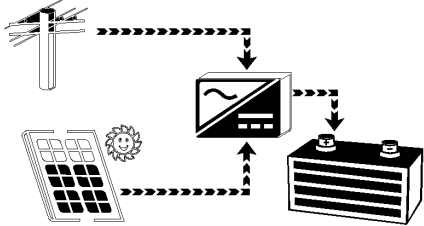
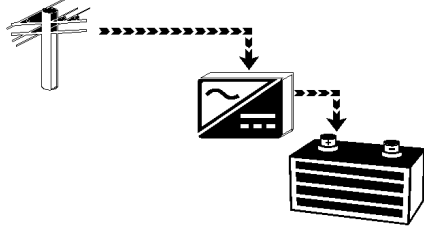
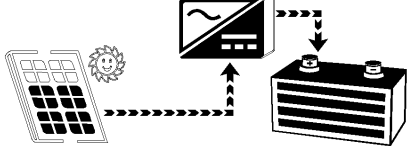
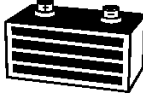
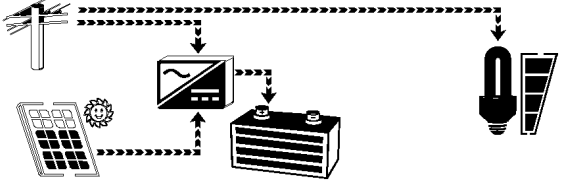
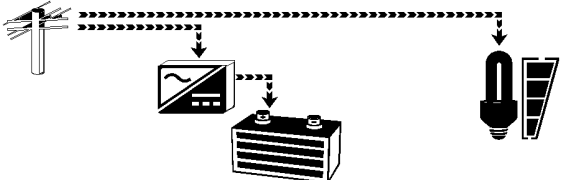
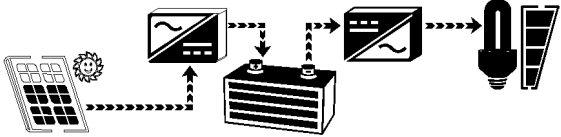
		<p>No charging.</p> 
<p>Fault mode Note: *Fault mode: Errors are caused by inside circuit error or external reasons such as over temperature, output short circuited and so on.</p>	<p>PV energy and utility can charge batteries.</p>	<p>Charging by utility and PV Energy</p>  <p>Charging by utility</p>  <p>Charging by PV energy</p>  <p>No charging</p> 
<p>Line Mode</p>	<p>The unit will provide output power from the mains. It will also charge the battery at line mode.</p>	<p>Charging by utility and PV energy.</p>  <p>Charging by utility.</p> 
<p>Battery Mode</p>	<p>The unit will provide output power from battery and PV power.</p>	<p>Power from battery and PV energy.</p>  <p>Power from battery only.</p>

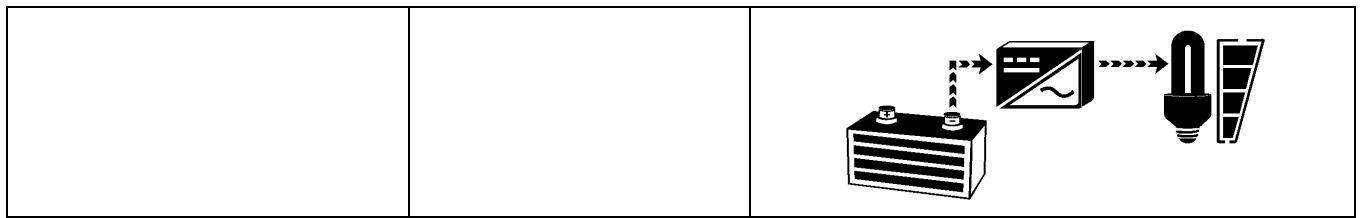

Alarm Behavior Table

Fault Code	Protect Function	Active Mode	Condition	Warning (O/P=ON)	Fault (O/P=OFF)	Restart	
						Operate	Condition
--	Low DC Voltage Alarm	Inv. mode	DC voltage<Low DC Alarm	1beep/2s	--	--	--
1	Over Charge Protection	Line mode	DC Voltage>High DC input Shut-down	Beep continuous	--	Manual	--
1	Over Voltage Protection	Standby	DC Voltage>High DC input Shut-down	--	Beep continuously	Auto	DC Voltage<High DC input Shut-down Recovery
2	Over Load Protection	Line/ Inv. mode	110%~150% load	1beep/0.5 s, and continue for 10s	Beep continuously	Manual	--
			>150% load	1beep/0.5 s, and continue for 5s	Beep continuously	Manual	--
3	Output Short Circuit protection	Inv. mode	Output Voltage<20Vrms	--	Beep continuously	Manual	--
4	Inverter Fan Fault Protection	Line/ Inv. mode	Fan Locked Fan Defected	2beep/2s , and continue for 1min	Beep continuously	Manual	--
5	Inverter Over Temp Protection	Line/ Inv. mode	HEAT SINK over temp	--	Beep continuously	Auto	HEAT SINK Temp≤ 55℃
6	Output Abnormal	Inv. mode	(Output Voltage <170Vrms and output current under 32Arms) or Output Voltage >280Vrms	--	Beep continuously	Manual	--

7	Bus Over Protection	Standby/Line/Inv. mode	Bus voltage over/AC Input and output reconnect	--	Beep continuously	Manual	--
11	SCC charger Current Over FAULT	SCC	SCC charger current over 60A(3K)	--	Beep 1time/2Second	Manual	--
12	SCC over temp.	SCC	SCC NTC Temperature over 85°C(3K)	--	Beep 1time/2Second	Manual	--
13	SCC Output voltage Over	SCC	SCC Output voltage over 32V(3K)	--	Beep 1time/2Second	Manual/Auto	SCC Output voltage low then 24V(3K)
14	SCC PV voltage Over	SCC	PV Input voltage over 75V(3K)	--	Beep 1time/2Second	Manual/Auto	PV Input voltage low then 65V(3K)

Note: when SCC Fault, press ENTER Key will clear this fault message.

- Unit will shut down after alarm for 1min, when unit on both fault mode and Switch-off mode. Unit will shut down immediately without any alarm, when unit on Switch-on mode with low DC input.

SPECIFICATIONS

MODEL	1KVA-12 +SCC(PWM)	1.5KVA-12/24 +SCC(PWM or MPPT)	3KVA-24 +SCC(PWM or MPPT)
CAPACITY	0.8KW/1KVA	1.2KW/1.5KVA	2.4KW/3KVA

Table 1 Line Mode Specifications

INPUT	1KVA-12	1.5KVA-12/24	3KVA-24
Input Voltage Waveform	Sinusoidal (utility or generator)		
Nominal Input Voltage	230Vac		
Low Loss Voltage	170Vac ± 7V(UPS) 90Vac ± 7V (Appliances)		
Low Loss Return Voltage	180Vac ± 7V (UPS) 100Vac ± 7V (Appliances)		
High Loss Voltage	280Vac ± 7V		
High Loss Return Voltage	270Vac ± 7V		
Max AC Input Voltage	300Vac		
Nominal Input Frequency	50Hz / 60Hz (Auto detection)		

Low Loss Frequency	40±1Hz		
Low Loss Return Frequency	42±1Hz		
High Loss Frequency	65±1Hz		
High Loss Return Frequency	63±1Hz		
OUTPUT	1KVA-12	1.5KVA-12/24	3KVA-24
Output Short Circuit Protection	Fuse		
Efficiency (Line Mode)	>95% (Rated R load, battery full charged)		
Transfer Time	10ms typical (UPS) 20ms typical (Appliances)		
Output power derating: When AC input voltage drops to 180V, the output power will be derated.			

Table 2 Inverter Mode Specifications

INVERTER MODEL	1KVA-12	1.5KVA-12	1.5KVA-24	3KVA-24
Rated Output Power	0.8KW/1KVA	1.2KW/1.5KVA		2.4KW/3KVA
OUTPUT				
Output Voltage Waveform	Pure Sine Wave			
Output Voltage Regulation	230Vac±5%			
Output Frequency	50Hz			
Peak Efficiency	93%			
Overload Protection	5s@>150% load; 10s@110%~150% load			
Surge Capacity	2* rated power for 5 seconds			
Nominal DC Input Voltage	12Vdc		24Vdc	
INPUT				
Cold Start Voltage	11.5Vdc		23.0Vdc	
Low DC Warning Voltage @ load < 50% @ load > 50%	11.5Vdc 11.0Vdc		23.0Vdc 22.0Vdc	
Low DC Warning Return Voltage @ load < 50% @ load > 50%	11.8Vdc 11.5Vdc		23.5Vdc 23.0Vdc	

Low DC Cut-off Voltage @ load < 50% @ load > 50%	10.5Vdc 10.0Vdc	21.0Vdc 20.0Vdc
High DC Recovery Voltage	32Vdc	32Vdc
High DC Cut-off Voltage	33Vdc	33Vdc
No Load Power Consumption	<20W	<25W

Table 3 Charge Mode Specifications

Utility Charging Mode					
INVERTER MODEL		1KVA-12	1.5KVA-12	1.5KVA-24	3KVA-24
Charging Algorithm		3-Step			
AC Charging Current (Max)		30Amp (@Vi/p=230Vac)			
Bulk Charging Voltage	Flooded Battery	14.6Vdc		29.2Vdc	
	AGM / Gel Battery	14.1Vdc		28.2Vdc	
Floating Charging Voltage		13.7Vdc		27.4Vdc	
Charging Curve		<p>Battery Voltage, per cell</p> <p>Charging Current, %</p> <p>2.43Vdc 2.35Vdc</p> <p>Voltage</p> <p>100%</p> <p>50%</p> <p>Current</p> <p>Time</p> <p>T0</p> <p>T1 = 10*T0, minimum 10 minutes, maximum 8 hours</p> <p>Bulk (Constant Current)</p> <p>Absorption (Constant voltage)</p> <p>Maintenance (Floating)</p>			
MPPT Solar Charging Mode					
Charging Current		N/A		40Amp	
PV Array MPPT Voltage Range		N/A		30-75Vdc	
Max. PV Array Open Circuit Voltage		N/A		75Vdc	
Max Charging Current (AC charger plus solar charger)		N/A		65 Amp	
PWM Solar Charging Mode					
Charging Current		50Amp			

System DC Voltage	12Vdc	24Vdc
Operating Voltage Range	15-18Vdc	30-32Vdc
Max. PV Array Open Circuit Voltage	50Vdc	60Vdc
Max Charging Current (AC charger plus solar charger)	75 Amp	

Table 4 General Specifications

INVERTER MODEL	1KVA-12	1.5KVA-12	1.5KVA-24	3KVA-24
Safety Certification	CE			
Operating Temperature Range	-10°C to 50°C			
Storage temperature	-15°C ~ 60°C			
Dimension (D*W*H)/ mm	105*288*345			
Net Weight ,kg (MPPT/PWM model)	6.2KG/6.0KG		6.6KG/6.4KG	

Troubleshooting

Problem	Possible Causes	Remedy
No LCD display	1. Battery weak	1. Re-charge battery
	2. Battery defective (can't be charged)	2. Battery replacement
	3. Power switch is not pressed	3. Press and hold power switch
	4. Battery polarity reversed, can't start up the unit	4. Contact dealer or supplier for service
Mains normal but works in inverter mode	1. AC Input is missing	1. Check AC input connection
	2. Input fuse broke	2. Replace the input fuse
PV input normal but works in inverter mode	1. PV weak	1. Check PV power or reduce loading
	2. PV input is missing	2. Check PV input connection
Alarm buzzer beeps continuously	1. Overload (fault code: F2)	1. Reduce loading so the loads' capacity is no larger than the upper limit
	2. Output short-circuited (fault code: F3)	2. Check wiring or remove abnormal load
	3. Inverter over-temperature (fault code: F5)	3. Check the ventilation at installed location and make sure the air vent of inverter is clear

	4. Over charging (fault code: F1)	4. Restart the unit, If the fault persists, contact dealer or supplier for service.
	5. Fan error (fault code: F4)	5. Check if the fan is blocked by obstacle. if not, contact dealer or supplier for service
	6. DC voltage is under low DC shut-down point (fault code: F0)	6. Make sure mains is normal to recharge the battery
	7. Output abnormal (fault code: F6)	7. Contact dealer or supplier for service
	8. Back-EMF (fault code: F7)	8. Check the AC Input and output wire connection
	9.SCC output over current (fault code: F11)	9.Check wiring or remove abnormal load
	10.SCC over temp(fault code: F12)	10. Check the ventilation at installed location and make sure the air vent of inverter is clear
	11.SCC Output over voltage(fault code: F13)	11. Restart the unit. If the fault persists, contact dealer or supplier for service
	12.SCC PV input over voltage (fault code: F14)	12.Check PV input voltage. If the voltage is normal, contact dealer or supplier for service
Back up time is shortened	1. Overload	1. Reduce the loading
	2. Battery voltage is too low	2. Charge battery for 8 hours or more
	3. Battery bank is too small	3. Increase battery bank capacity

Note: If the unit fails to operate properly after installation and the setup has been re-examined thoroughly, use the troubleshooting table to determine the probable cause and remedy. For unlisted faults, please contact your local dealer or supplier for service assistances.

Appendix: Approximate Back-up Time Table

Model	Load (VA)	Backup Time @ 24Vdc 100Ah (min)	Backup Time @ 24Vdc 200Ah (min)
1KVA	200	766	1610
	400	335	766
	600	198	503
	800	139	339
	1000	112	269
3KVA	300	449	1100
	600	222	525
	900	124	303
	1200	95	227
	1500	68	164
	1800	56	126
	2100	48	108
	2400	35	94
	2700	31	74
	3000	28	67

Model	Load (VA)	Backup Time @ 12Vdc 100Ah (min)	Backup Time @ 12Vdc 200Ah (min)
1KVA	100	766	1610
	200	335	766
	300	198	503
	400	139	339
	500	112	269
	600	95	227
	700	81	176
	800	62	140
	900	55	125
	1000	50	112